

modular pratika dishwashing

PANNELLO DI CONTROLLO ANALOGICO 2 programmi
ANALOGIC CONTROL PANEL 2 programs
TABLEAU DE CONTRÔLE MÉCANIQUE 2 programmes

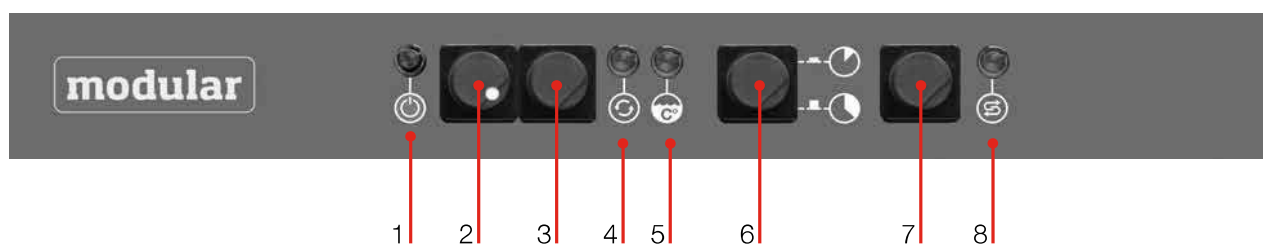

PANNELLO DI CONTROLLO ANALOGICO

- 1) Lampada macchina accesa
- 2) Interruttore On / Off
- 3) Avvio ciclo lavaggio / Avvio scarico (per modelli con pompa scarico)
- 4) Lampada ciclo lavaggio in funzione / scarico
- 5) Lampada macchina in temperatura
- 6) Selezione ciclo
- 7) Avvio rigenerazione (solo per modelli dotati di addolcitore)
- 8) Lampada avviso rigenerazione / rigenerazione in corso

ANALOGIC CONTROL PANEL

- 1) On / Off led
- 2) On / Off switch
- 3) Washing cycle start button / Drain cycle start button (for models with drain pump)
- 4) Washing cycle led / drain cycle led
- 5) Dishwasher machine temperature led
- 6) Cycle selector
- 7) Water softener cycle start button (only for models with water softener)
- 8) Water softener led / water softening in progress

TABLEAU DE CONTRÔLE MÉCANIQUE

- 1) Voyant machine allumée
- 2) Touche On / Off
- 3) Actionnement cycle de lavage / Actionnement vidange (pour modèles avec pompe de vidange)
- 4) Voyant cycle de lavage en fonction / vidange
- 5) Voyant machine en température
- 6) Sélection cycle
- 7) Actionnement adoucisseur (seulement pour modèles avec adoucisseur)
- 8) Avis régénération / régénération en cours

pratika dishwashing

DWD 45 - DWD 45 DT

modelli a doppia parete / double skin models / modeles a double paroi

lavapiatti analogica, 2 programmi

dishwasher analogic model, 2 programs

lave vaisselle commandes mécaniques, 2 programmes

CARATTERISTICHE COSTRUTTIVE: • Realizzazione in acciaio Inox 18/10 Aisi 304 • Vasca stampata • Costruzione doppia parete • Porta doppia parete • Gruppo aspirazione/scarico integrato per scarico totale del circuito con filtro in Acciaio Inox 18/10 Aisi 304 • Giranti di lavaggio e risciacquo separate realizzate in acciaio Inox 18/10 Aisi 304 • Lavaggio superiore • Dosatore brillantante incorporato • 2 cicli di lavaggio (20 o 30 cesti ora) • Termostop • Boiler a pressione • Predisposizione per allacciamento dosatore detersivo e pompa scarico • Alimentazione $\geq 50^{\circ}\text{C}$

CONSTRUCTION FEATURES: • Double skin structure • Made of stainless steel 18/10 Aisi 304 • Deep-formed tank • Double skin door • Integrated suction/discharge circuit for total draining with Aisi 304 stainless steel filter • Independent upper and lower washing/rinsing Aisi 304 stainless steel arms • Built-in rinse aid dispenser • 2 washing programs (20/30 racks/h) • Thermostop • Pressure boiler • External detergent dispenser and drainpump as an option • Water inlet temperature $\geq 50^{\circ}\text{C}$

CARACTÉRISTIQUES DE CONSTRUCTION: • Structure à double paroi • Fabrication en acier Inox 18/10 Aisi 304 • Cuve de lavage emboutie, à angles arrondis • Porte double paroi • Groupe aspiration/vidange intégré pour la vidange totale du circuit, avec filtre en acier Inox 18/10 Aisi 304 • Bras de lavage et de rinçage séparés en acier Inox Aisi 304 • Lavage supérieur • Doseur produit de rinçage intégré • 2 cycles de lavage (20/30 casiers/h) • Thermostop • Chaudière à pression • Doseur détergent et pompe de vidange en option • Température de l'eau à l'arrivée $\geq 50^{\circ}\text{C}$

DWD 45

51x59,5x80,5 h cm

62 Kg

0,34 m³

2.360 €

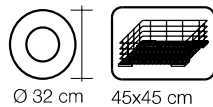

3,35 kW
220-240V 1N 50Hz

Voltaggio 60Hz disponibile su richiesta con sovrapprezzo / Voltage 60Hz available on request, additional cost / Voltage 60Hz disponible sur demande, coût additionnel

lavapiatti digitale, 3 programmi

dishwasher digital model, 3 programs

lave vaisselle commandes électroniques, 3 programmes

CARATTERISTICHE COSTRUTTIVE: • Realizzazione in acciaio Inox 18/10 Aisi 304 • Vasca stampata • Costruzione doppia parete • Porta doppia parete • Gruppo aspirazione/scarico integrato per scarico totale del circuito con filtro in acciaio Inox 18/10 Aisi 304 • Giranti di lavaggio e risciacquo separate realizzate in acciaio Inox 18/10 Aisi 304 • Lavaggio superiore • Dosatore brillantante incorporato • 3 cicli di lavaggio (20/30/40 cesti ora) • Termostop • Boiler a pressione • Predisposizione per allacciamento dosatore detersivo e pompa scarico • Alimentazione $\geq 50^{\circ}\text{C}$

CONSTRUCTION FEATURES: • Double skin structure • Made of Stainless Steel 18/10 Aisi 304 • Deep-formed tank • Double skin door • Integrated suction/discharge circuit for total draining with Aisi 304 stainless steel filter • Independent upper and lower washing/rinsing Aisi 304 stainless steel arms • Built-in rinse aid dispenser • Digital control panel with 3 washing programs (20/30/40 racks/h) • Thermostop • Pressure boiler • External detergent dispenser and drain pump as an option • Water inlet temperature $\geq 50^{\circ}\text{C}$

CARACTÉRISTIQUES DE CONSTRUCTION: • Structure à double paroi • Fabrication en acier Inox 18/10 Aisi 304 • Cuve de lavage emboutie, à angles arrondis • Porte double paroi • Groupe aspiration/vidange intégré pour la vidange totale du circuit, avec filtre en acier Inox 18/10 Aisi 304 • Bras de lavage et de rinçage séparés en acier Inox Aisi 304 • Lavage supérieur • Doseur produit de rinçage intégré • 3 cycles de lavage (20/30/40 casiers/h) • Thermostop • Chaudière à pression • Doseur détergent et pompe de vidange en option • Température de l'eau à l'arrivée $\geq 50^{\circ}\text{C}$

DWD 45 DT

51x59,5x80,5 h cm

62 Kg

0,34 m³

2.446 €

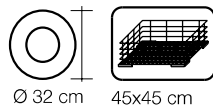







3,35 kW
220-240V 1N 50Hz

Voltaggio 60Hz disponibile su richiesta con sovrapprezzo / Voltage 60Hz available on request, additional cost / Voltage 60Hz disponible sur demande, coût additionnel

optional

optional
en option

A  281 €	Addolcitore incorporato (da richiedere all'ordine)	L/DD  163 €	Dosatore detergente
	Built-in water softener (to request at order)		Detergent dispenser
	Adoucisseur intégré (à demander au moment de la commande)		Doseur détergent
L/PR  273 €	Pompa ausiliaria risciacquo 0,33 kW	L/PS  176 €	Pompa scarico 0,025 kW
	Rinse-booster pump 0,33 kW		Drain pump 0,025 kW
	Pompe auxiliaire rinçage 0,33 kW		Pompe de vidange 0,025 kW
L/RF*  96 €	Risciacquo freddo (da richiedere all'ordine)	L/PS DT  176 €	Pompa scarico 0,025 kW per modelli digitali
	Cold rinse (to request at order)		Drain pump 0,025 kW for digital models
	Rinçage à froid (à demander au moment de la commande)		Pompe de vidange 0,025 kW pour modèles commandes électroniques

*Solo per modello DWD 45 - Only for DWD 45 model - Seulement pour modèle DWD 45

dotazione

included accessories
équipement inclus

Cesto per bicchieri Rack for glasses Panier à verres		Inserto piattini Saucers insert Support soucoupes		Inserto posate Cutlery insert Godet à couverts		Cesto per piatti Rack for plates Panier à assiettes	14 7	 Ø 24 cm Ø 32 cm	
--	---	---	---	--	---	---	---------	--	---

pratika dishwashing

DW 50 - DW 51

modelli mono parete / single skin models / modeles a simple paroi

lavapiatti analogiche, 2 programmi





dishwasher analogic models, 2 programs

lave vaisselle commandes mécaniques, 2 programmes

CARATTERISTICHE COSTRUTTIVE: • Realizzazione in acciaio Inox 18/10 Aisi 304 • Vasca stampata • Costruzione monoparete • Porta doppiaparete • Gruppo aspirazione/scarico integrato per scarico totale del circuito con filtro in acciaio Inox 18/10 Aisi 304 • Giranti di lavaggio e risciacquo separate realizzate in acciaio Inox 18/10 Aisi 304 • Lavaggio superiore • Dosatore brillantante incorporato • 2 cicli di lavaggio (20/30 cesti ora) • Termostop • Boiler a pressione • Predisposizione per allacciamento dosatore detersivo e pompa scarico • Alimentazione ≥ 50°C

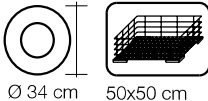
CONSTRUCTION FEATURES: • Made of stainless steel 18/10 Aisi 304 • Deep-formed tank • Single skin structure • Double skin door • Integrated suction /discharge circuit for total draining with Aisi 304 stainless steel filter • Independent upper and lower washing/rinsing Aisi 304 stainless steel arms • Built-in rinse aid dispenser • 2 washing programs (20/30 racks/h) • Thermostop • Pressure boiler • External detergent dispenser and drain pump as an option • Water inlet temperature ≥ 50°C

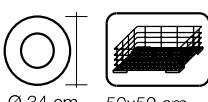
CARACTÉRISTIQUES DE CONSTRUCTION: • Structure à paroi simple • Fabrication en acier Inox 18/10 Aisi 304 • Cuve de lavage emboutie, à angles arrondis • Porte double paroi • Groupe aspiration/vidange intégré pour la vidange totale du circuit, avec filtre en acier Inox 18/10 Aisi 304 • Bras de lavage et de rinçage séparés en acier Inox Aisi 304 • Lavage supérieur • Doseur produit de rinçage intégré • 2 cycles de lavage (20/30 casiers/h) • Thermostop • Chaudière à pression • Doseur détergent et pompe de vidange en option • Température de l'eau à l'arrivée ≥ 50°C

<p>DW 50 60x62,5x82 h cm 63 Kg 0,43 m³ 2.515 €</p>		 <p>3,65 kW 220-240V 1N 50Hz</p>
<p>DW 51 60x62,5x82 h cm 63 Kg 0,43 m³ 2.608 €</p>		 <p>5,15 kW 380-415V 3N 50Hz *5,15 kW 220-240V 3 50Hz</p>





* disponibile su richiesta / available on request / disponible sur demande

Voltaggio 60Hz disponibile su richiesta con sovrapprezzo / Voltage 60Hz available on request, additional cost / Voltage 60Hz disponible sur demande, coût additionnel

optional

optional

en option

<p>A</p>  <p>281 €</p>	<p>Addolcitore incorporato (da richiedere all'ordine)</p> <p>Built-in water softener (to request at order)</p> <p>Adoucisseur intégré (à demander au moment de la commande)</p>	<p>L/DD</p>  <p>163 €</p>	<p>Dosatore detersive</p> <p>Detergent dispenser</p> <p>Doseur détergent</p>
<p>L/PR</p>  <p>273 €</p>	<p>Pompa ausiliaria risciacquo 0,33 kW</p> <p>Rinse-booster pump 0,33 kW</p> <p>Pompe auxiliaire rinçage 0,33 kW</p>	<p>L/PS</p>  <p>176 €</p>	<p>Pompa scarico 0,025 kW</p> <p>Drain pump 0,025 kW</p> <p>Pompe de vidange 0,025 kW</p>
<p>L/RF</p>  <p>96 €</p>	<p>Risciacquo freddo (da richiedere all'ordine)</p> <p>Cold rinse (to request at order)</p> <p>Rinçage à froid (à demander au moment de la commande)</p>		

dotazione

included accessories

équipement inclus

<p>Cesto per bicchieri Rack for glasses Panier à verres</p>	 <p>2 inserti posate 2 Cutlery inserts 2 godets à couverts</p>	 <p>Cesto per piatti Rack for plates Panier à assiettes</p>	<p>20  Ø 24 cm 10  Ø 34 cm</p>	
---	---	---	--	---

DW 50 DT - DW 51 DT

modelli mono parete / single skin models / modeles a simple paroi

lavapiatti digitale, 3 programmi

dishwasher digital model, 3 programs

lave vaisselle commandes électroniques, 3 programmes

CARATTERISTICHE COSTRUTTIVE: • Realizzazione in acciaio Inox 18/10 Aisi 304 • Vasca stampata • Costruzione monoparete • Porta doppia parete • Gruppo aspirazione/scarico integrato per scarico totale del circuito con filtro in acciaio Inox 18/10 Aisi 304 • Giranti di lavaggio e risciacquo separate realizzate in acciaio Inox 18/10 Aisi 304 • Lavaggio superiore • Dosatore brillantante incorporato • 3 cicli di lavaggio (20/30/40 cesti ora) • Termostop • Boiler a pressione • Predisposizione per allacciamento dosatore detersivo e pompa scarico • Alimentazione $\geq 50^{\circ}\text{C}$

CONSTRUCTION FEATURES: • Single skin structure • Made of stainless steel 18/10 Aisi 304 • Deep-formed tank • Double skin door • Integrated suction/discharge circuit for total draining with Aisi 304 stainless steel filter • Independent upper and lower washing/rinsing Aisi 304 stainless steel arms • Built-in rinse aid dispenser • Digital control panel with 3 washing programs (20/30/40 racks/h) • Thermostop • Pressure boiler • External detergent dispenser and drain pump as an option • Water inlet temperature $\geq 50^{\circ}\text{C}$

CARACTÉRISTIQUES DE CONSTRUCTION: • Structure à paroi simple • Fabrication en acier Inox 18/10 Aisi 304 • Cuve de lavage emboutie, à angles arrondis • Porte à double paroi • Groupe aspiration/vidange intégré pour la vidange totale du circuit, avec filtre en acier Inox 18/10 Aisi 304 • Bras de lavage et de rinçage séparés en acier Inox Aisi 304 • Lavage supérieur • Doseur produit de rinçage intégré • 3 cycles de lavage (20/30/40 casiers/h) • Thermostop • Chaudière à pression • Doseur détergent et pompe de vidange en option • Température de l'eau à l'arrivée $\geq 50^{\circ}\text{C}$

DW 50 DT 60x62,5x82 h cm 63 Kg 0,43 m ³ 2.638 €		 3,65 kW 220-240V 1N 50Hz
DW 51 DT 60x62,5x82 h cm 63 Kg 0,43 m ³ 2.703 €		 5,15 kW 380-415V 3N 50Hz *5,15 kW 220-240V 3 50Hz







* disponibile su richiesta / available on request / disponible sur demande

Voltaggio 60Hz disponibile su richiesta con sovrapprezzo / Voltage 60Hz available on request, additional cost / Voltage 60Hz disponible sur demande, coût additionnel

optional

optional

en option

A  281 €	Addolcitore incorporato (da richiedere all'ordine) Built-in water softener (to request at order) Adoucisseur intégré (à demander au moment de la commande)	L/DD  163 €	Dosatore detergente Detergent dispenser Doseur détergent
L/PR  273 €	Pompa ausiliaria risciacquo 0,33 kW Rinse-booster pump 0,33 kW Pompe auxiliaire rinçage 0,33 kW	L/PS  176 €	Pompa scarico 0,025 kW Drain pump 0,025 kW Pompe de vidange 0,025 kW
L/PS DW DT  176 €	Pompa scarico 0,025 kW per modelli digitali DW Drain pump 0,025 kW for digital models DW Pompe de vidange 0,025 kW pour modèles commandes électroniques DW	BT  409 €	Break Tank (da richiedere all'ordine) Break Tank (to request at order) Air Gap (à demander au moment de la commande)

dotazione

included accessories

équipement inclus

Cesto per bicchieri
 Rack for glasses
 Panier à verres

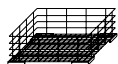

2 inserti posate
 2 Cutlery inserts
 2 godets à couverts



Cesto per piatti
 Rack for plates
 Panier à assiettes

20  Ø 24 cm
 10  Ø 34 cm



pratika dishwashing

DWD 51 - DWD 51 DT

modelli doppia parete / double skin models / modeles a double paroi

lavapiatti analogica, 2 programmi

dishwasher analogic model, 2 programs

lave vaisselle commandes mécaniques, 2 programmes

CARATTERISTICHE COSTRUTTIVE: • Costruzione doppia parete • Realizzazione in acciaio Inox 18/10 Aisi 304 • Vasca stampata • Porta doppia parete • Porta bilanciata con molle • Gruppo aspirazione/scarico integrato per scarico totale del circuito con doppio filtro in Acciaio Inox 18/10 Aisi 304 • Giranti di lavaggio e risciacquo separate realizzate in acciaio Inox 18/10 Aisi 304 • Lavaggio superiore • Dosatore brillantante • 2 cicli di lavaggio (20/30 cesti ora) • Termostop • Boiler a pressione • Predisposizione per allacciamento dosatore detersivo pompa di scarico • Alimentazione $\geq 50^{\circ}\text{C}$

CONSTRUCTION FEATURES: • Made of stainless steel 18/10 Aisi 304 • Deep-formed tank • Double skin structure • Balanced double skin door • Integrated suction/discharge circuit for total draining with Aisi 304 stainless steel filter • Independent upper and lower washing/rinsing Aisi 304 stainless steel arms • Built-in rinse aid dispenser • 2 washing programs (20/30 racks/h) • Termostop • Pressure boiler • External detergent dispenser and drain pump as an option • Water inlet temperature $\geq 50^{\circ}\text{C}$

CARACTÉRISTIQUES DE CONSTRUCTION: • Structure à double paroi • Fabrication en acier Inox 18/10 Aisi 304 • Cuve de lavage emboutie, à angles arrondis • Porte à double paroi balancée avec ressorts • Groupe aspiration/vidange intégré pour la vidange totale du circuit, avec filtre en acier Inox 18/10 Aisi 304 • Bras de lavage et de rinçage séparés en acier Inox Aisi 304 • Lavage supérieur • Doseur produit de rinçage intégré • 2 cycles de lavage (20/30 casiers/h) • Thermostop • Chaudière à pression • Prêdisposé pour doseur détergent et pompe de vidange en option • Température de l'eau à l'arrivée $\geq 50^{\circ}\text{C}$

DWD 51 60x62,5x82 h cm 69 Kg 0,43 m ³ 3.186 €	 Ø 31 cm 50x50 cm	 5,15 kW 380-415V 3N 50Hz *5,15 kW 220-240V 3 50Hz *3,65 kW 220-240V 1N 50Hz
--	---	---

* disponibile su richiesta / available on request / disponibles sur demande

Voltaggio 60Hz disponibile su richiesta con sovrapprezzo / Voltage 60Hz available on request, additional cost / Voltage 60Hz disponible sur demande, coût additionnel

lavapiatti digitale, 3 programmi



dishwasher digital model, 3 programs

lave vaisselle commandes électroniques, 3 programmes

CARATTERISTICHE COSTRUTTIVE: • Costruzione doppia parete • Realizzazione in acciaio Inox 18/10 Aisi 304 • Vasca stampata • Porta bilanciata con molle • Gruppo aspirazione/scarico integrato per scarico totale del circuito con doppio filtro in acciaio Inox 18/10 Aisi 304 • Giranti di lavaggio e risciacquo separate realizzate in acciaio Inox 18/10 Aisi 304 • Lavaggio superiore • Dosatore brillantante • 3 cicli di lavaggio (20/30/40 cesti ora) • Termostop • Boiler a pressione • Predisposizione per allacciamento dosatore detersivo e pompa di scarico • Alimentazione $\geq 50^{\circ}\text{C}$

CONSTRUCTION FEATURES: • Double skin structure • Made of stainless steel 18/10 Aisi 304 • Deep-formed tank • Double skin door • Integrated suction/discharge circuit for total draining with Aisi 304 stainless steel filter • Independent upper and lower washing/rinsing Aisi 304 stainless steel arms • Built-in rinse aid dispenser • Digital control panel with 3 washing programs (20/30/40 racks/h) • Thermostop • Pressure boiler • External detergent dispenser and drain pump as an option • Water inlet temperature $\geq 50^{\circ}\text{C}$

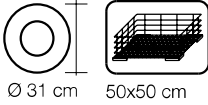
CARACTÉRISTIQUES DE CONSTRUCTION: • Structure à double paroi • Fabrication en acier Inox 18/10 Aisi 304 • Cuve de lavage emboutie, à angles arrondis • Porte balancée avec ressorts • Groupe aspiration/vidange intégré pour la vidange totale du circuit, avec filtre en acier Inox 18/10 Aisi 304 • Bras de lavage et de rinçage séparés en acier Inox Aisi 304 • Lavage supérieur • Doseur produit de rinçage intégré • 3 cycles de lavage (20/30/40 casiers/h) • Thermostop • Chaudière à pression • Prêdisposé pour doseur détergent et pompe de vidange en option • Température de l'eau à l'arrivée $\geq 50^{\circ}\text{C}$

DWD 51 DT 60x62,5x82 h cm 69 Kg 0,43 m ³ 3.295 €	 Ø 31 cm 50x50 cm	 5,15 kW 380-415V 3N 50Hz *5,15 kW 220-240V 3 50Hz *3,65 kW 220-240V 1N 50Hz
---	---	---

* disponibile su richiesta / available on request / disponibles sur demande

Voltaggio 60Hz disponibile su richiesta con sovrapprezzo / Voltage 60Hz available on request, additional cost / Voltage 60Hz disponible sur demande, coût additionnel

dotazione

included accessories

équipement inclus

Cesto per bicchieri
Rack for glasses
Panier à verres



2 inserti posate
2 Cutlery inserts
2 godets à couverts



Cesto per piatti
Rack for plates
Panier à assiettes

20
10

Ø 24 cm
Ø 34 cm



DWD 59 - DWD 59 DT

modelli doppia parete / double skin models / modeles a double paroi

lavapiatti analogica, 2 programmi



dishwasher analogic model, 2 programs

lave vaisselle commandes mécaniques, 2 programmes

CARATTERISTICHE COSTRUTTIVE: • Costruzione doppia parete • Realizzazione in acciaio Inox 18/10 Aisi 304 • Vasca stampata • Porta doppia parete • Porta bilanciata con molle • Gruppo aspirazione/scarico integrato per scarico totale del circuito con doppio filtro in acciaio Inox 18/10 Aisi 304 • Giranti di lavaggio e risciacquo separate realizzate in acciaio Inox 18/10 Aisi 304 • Lavaggio superiore • Dosatore brillantante • 2 cicli di lavaggio (30/45 cesti ora) • Termostop • Boiler a pressione • Predisposizione per allacciamento dosatore detersivo e pompa di scarico • Alimentazione $\geq 50^{\circ}\text{C}$

CONSTRUCTION FEATURES: • Made of stainless steel 18/10 Aisi 304 • Deep-formed tank • Double skin structure • Balanced double skin door • Integrated suction/discharge circuit for total draining with Aisi 304 stainless steel filter • Independent upper and lower washing/rinsing Aisi 304 stainless steel arms • Built-in rinse aid dispenser • 2 washing programs (30/45 racks/h) • Thermostop • Pressure boiler • External detergent dispenser and drain pump as an option • Water inlet temperature $\geq 50^{\circ}\text{C}$

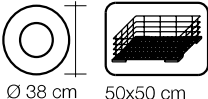
CARACTÉRISTIQUES DE CONSTRUCTION: • Structure à double paroi • Fabrication en acier Inox 18/10 Aisi 304 • Cuve de lavage emboutie, à angles arrondis • Porte à double paroi balancée avec ressorts • Groupe aspiration/vidange intégré pour la vidange totale du circuit, avec filtre en acier Inox 18/10 Aisi 304 • Bras de lavage et de rinçage séparés en acier Inox Aisi 304 • Lavage supérieur • Doseur produit de rinçage intégré • 2 cycles de lavage (30/45 casiers/h) • Thermostop • Chaudière à pression • Prédisposé pour doseur détergent et pompe de vidange en option • Température de l'eau à l'arrivée $\geq 50^{\circ}\text{C}$

<p>DWD 59 60x62,5x136 h cm 85 Kg 0,61 m³ 3.551 €</p>	 <p>Ø 38 cm 50x50 cm</p>	 <p>6,75 kW 380-415V 3N 50Hz *5,25 kW 220-240V 3 50Hz</p>
---	---	---

* disponibile su richiesta / available on request / disponible sur demande
 Voltaggio 60Hz disponibile su richiesta con sovrapprezzo / Voltage 60Hz available on request, additional cost / Voltage 60Hz disponible sur demande, coût additionnel

lavapiatti digitale, 3 programmi

dishwasher digital model, 3 programs

lave vaisselle commandes électroniques, 3 programmes

CARATTERISTICHE COSTRUTTIVE: • Costruzione doppia parete • Realizzazione in acciaio Inox 18/10 Aisi 304 • Vasca stampata • Porta doppia parete • Gruppo aspirazione/scarico integrato per scarico totale del circuito con doppio filtro in acciaio Inox 18/10 Aisi 304 • Giranti di lavaggio e risciacquo separate realizzate in acciaio Inox 18/10 Aisi 304 • Lavaggio superiore • Dosatore brillantante • 3 cicli di lavaggio (20/30/45 cesti ora) • Termostop • Boiler a pressione • Predisposizione per allacciamento dosatore detersivo e pompa di scarico • Alimentazione $\geq 50^{\circ}\text{C}$

CONSTRUCTION FEATURES: • Double skin structure • Made of stainless steel 18/10 Aisi 304 • Deep-formed tank • Double skin door • Integrated suction/discharge circuit for total draining with Aisi 304 stainless steel filter • Independent upper and lower washing/rinsing Aisi 304 stainless steel arms • Built-in rinse aid dispenser • Digital control panel with 3 washing programs (20/30/45 racks/h) • Thermostop • Boiler pressure • External detergent dispenser and drain pump as an option • Water inlet temperature $\geq 50^{\circ}\text{C}$

CARACTÉRISTIQUES DE CONSTRUCTION: • Structure à double paroi • Fabrication en acier Inox 18/10 Aisi 304 • Cuve de lavage emboutie, à angles arrondis • Porte double paroi • Groupe aspiration/vidange intégré pour la vidange totale du circuit, avec filtre en acier Inox 18/10 Aisi 304 • Bras de lavage et de rinçage séparés en acier Inox Aisi 304 • Lavage supérieur • Doseur produit de rinçage intégré • 3 cycles de lavage (20/30/45 casiers/h) • Thermostop • Chaudière à pression • Prédisposé pour doseur détergent et pompe de vidange en option • Température de l'eau à l'arrivée $\geq 50^{\circ}\text{C}$

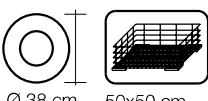
<p>DWD 59 DT 60x62,5x136 h cm 85 Kg 0,61 m³ 3.659 €</p>	 <p>Ø 38 cm 50x50 cm</p>	 <p>6,75 kW 380-415V 3N 50Hz *5,25 kW 220-240V 3 50Hz</p>
--	---	---

* disponibile su richiesta / available on request / disponible sur demande
 Voltaggio 60Hz disponibile su richiesta con sovrapprezzo / Voltage 60Hz available on request, additional cost / Voltage 60Hz disponible sur demande, coût additionnel

dotazione

included accessories

équipement inclus

Cesto per posate
Rack for cutlery
Panier à couverts

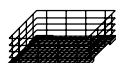

2 cesti per piatti
2 racks for platesw
2 paniers à assiettes







20  Ø 26 cm
10  Ø 38 cm



optional per modelli lavapiatti analogici e digitali DW - DWD

optional for analogic and digital dishwashers DW - DWD

en option pour modèles lave vaisselles commandes mécaniques et électroniques DW - DWD

A  281 €	Addolcitore incorporato (da richiedere all'ordine)	L/DD  163 €	Dosatore detergente
	Built-in water softener (to request at order)		Detergent dispenser
	Adoucisseur intégré (à demander au moment de la commande)		Doseur détergent
L/PR  273 €	Pompa ausiliaria risciacquo 0,33 kW	L/PS  176 €	Pompa scarico 0,025 kW
	Rinse-booster pump 0,33 kW		Drain pump 0,025 kW
	Pompe auxiliaire rinçage 0,33 kW		Pompe de vidange 0,025 kW
L/RF *  96 €	Risciacquo freddo (da richiedere all'ordine)	L/PS DW DT  176 €	Pompa scarico 0,025 kW per modelli digitali DW
	Cold rinse (to request at order)		Drain pump 0,025 kW for digital models DW
	Rinçage à froid (à demander au moment de la commande)		Pompe de vidange 0,025 kW pour modèles commandes électroniques DW
BT  409 €	Break Tank (solo per modelli digitali)		
	Break Tank (only for digital models)		
	Air Gap (seulement pour modèles électroniques)		

*Solo per modello DWD 51 e DWD 59 - Only for DWD 51 and DWD 59 model - Seulement pour modèles DWD 51 et DWD 59

HT 50 - HT 51

modelli mono parete / single skin models / modeles a simple paroi

capottina analogica, 2 programmi



hood type analogic model, 2 programs

lave vaisselle à capot commandes mécaniques, 2 programmes

CARATTERISTICHE COSTRUTTIVE: • Realizzazione in acciaio Inox 18/10 Aisi 304 • Vasca stampata • Gruppo aspirazione/scarico integrato per scarico totale del circuito con filtro in acciaio Inox 18/10 Aisi 304 • Giranti di lavaggio e risciacquo unite con circuito separato • Dosatore brillantante incorporato • 2 cicli di lavaggio (30/45 cesti/h) • Partenza automatica • Termostop • Boiler a pressione • Predisposizione per allacciamento dosatore detersivo e pompa di scarico • Alimentazione ≥ 50°C

CONSTRUCTION FEATURES: • Made of stainless steel 18/10 Aisi 304 • Deep-formed tank • Integrated suction/discharge circuit for total draining with Aisi 304 stainless steel filter • United upper and lower washing/rinsing arms • Built-in rinse aid dispenser • 2 washing programs (30/45 racks/h) • Automatic start • Thermostop • Pressure boiler • External detergent dispenser and drain pump as an option • Water inlet temperature ≥ 50°C

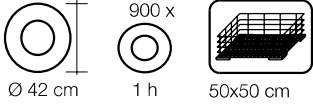
CARACTÉRISTIQUES DE CONSTRUCTION: • Fabrication en acier Inox 18/10 Aisi 304 • Cuve de lavage emboutie, à angles arrondis • Groupe aspiration/vidange intégré pour la vidange totale du circuit, avec filtre en acier Inox 18/10 Aisi 304 • Bras de lavage et de rinçage unis avec circuit séparé • Doseur produit de rinçage intégré • 2 cycles de lavage (30/45 casiers/h) • Marche automatique • Thermostop • Chaudière à pression • Prédisposé pour doseur détergent et pompe de vidange en option • Température de l'eau à l'arrivée ≥ 50°C

<p>HT 50 63,5x71,7x140,5 h cm 140 Kg 0,96 m³ 4.642 €</p>	 <p>Ø 42 cm 900 x 1 h 50x50 cm</p>	 <p>6,75 kW 380-415V 3N 50Hz *6,75 kW 220-240V 3 50Hz</p>
--	---	---

* disponibile su richiesta / available on request / disponible sur demande

Voltaggio 60Hz disponibile su richiesta con sovrapprezzo / Voltage 60Hz available on request, additional cost / Voltage 60Hz disponible sur demande, coût additionnel

capottina analogica, 2 programmi



hood type analogic model, 2 programs

lave vaisselle à capot commandes électroniques, 2 programmes

CARATTERISTICHE COSTRUTTIVE: • Realizzazione in acciaio Inox 18/10 Aisi 304 • Vasca stampata • Doppio filtro vasca in acciaio inox • Gruppo aspirazione/scarico integrato per scarico totale del circuito con filtro in acciaio Inox 18/10 Aisi 304 • Giranti di lavaggio e risciacquo separate realizzate in acciaio inox 18/10 Aisi 304 • Dosatore brillantante incorporato • 2 cicli di lavaggio (30/60 cesti/h) • Partenza automatica • Termostop • Boiler a pressione • Termometri temperatura vasca e temperatura boiler • Predisposizione per allacciamento dosatore detersivo e pompa di scarico • Alimentazione ≥ 50°C

CONSTRUCTION FEATURES: • Made of stainless steel 18/10 Aisi 304 • Deep-formed tank • Integrated suction/discharge circuit for total draining • Double Aisi 304 stainless steel tank filter + pump filter • Independent upper and lower washing/rinsing Aisi 304 stainless steel arms • Built-in rinse aid dispenser • 2 washing programs (30/60 racks/h) • Automatic start • Thermostop • Pressure boiler • Tank and boiler thermometers • External detergent dispenser and drain pump as an option • Water inlet temperature ≥ 50°C

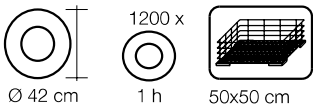
CARACTÉRISTIQUES DE CONSTRUCTION: • Fabrication en acier Inox 18/10 Aisi 304 • Cuve de lavage emboutie, à angles arrondis • Double filtre cuve en acier inox • Groupe aspiration/vidange intégré pour la vidange totale du circuit, avec filtre en acier Inox 18/10 Aisi 304 • Bras de lavage et de rinçage séparés en acier Inox Aisi 304 • Doseur produit de rinçage intégré • 2 cycles de lavage (30/60 casiers/h) • Marche automatique • Thermostop • Chaudière à pression • Thermomètres visualisation température cuve et chaudière • Prédisposé pour doseur détergent et pompe de vidange en option • Température de l'eau à l'arrivée ≥ 50°C

<p>HT 51 63,5x71,7x140,5 h cm 140 Kg 0,96 m³ 5.120 €</p>	 <p>Ø 42 cm 1200 x 1 h 50x50 cm</p>	 <p>8,75 kW 380-415V 3N 50Hz *6,75 kW 220-240V 3 50Hz</p>
--	--	---

* disponibile su richiesta / available on request / disponible sur demande

Voltaggio 60Hz disponibile su richiesta con sovrapprezzo / Voltage 60Hz available on request, additional cost / Voltage 60Hz disponible sur demande, coût additionnel

pratika dishwashing

HT 52 DT - HT 53 DT

modelli mono parete / single skin models / modeles a simple paroi

capottine digitali, 3 programmi





hood type digital model, 3 programs

lave vaisselle à capot commandes électroniques, 3 programmes

CARATTERISTICHE COSTRUTTIVE: • Realizzazione in acciaio Inox 18/10 Aisi 304 • Vasca stampata • Doppio filtro vasca in acciaio inox • Gruppo aspirazione/scarico integrato per scarico totale del circuito con filtro in acciaio Inox 18/10 Aisi 304 • Giranti di lavaggio e risciacquo separate realizzate in acciaio Inox 18/10 Aisi 304 • Dosatore brillantante incorporato • 3 cicli di lavaggio (24/36/65 cesti/h) • Partenza automatica • Termostop • Boiler a pressione • Termometri temperatura vasca e temperatura boiler • Predisposizione per allacciamento dosatore detersivo e pompa di scarico • Alimentazione ≥ 50°C

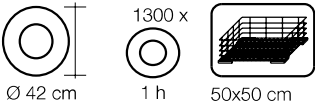
CONSTRUCTION FEATURES: • Made of stainless steel 18/10 Aisi 304 • Deep-formed tank • Integrated suction/discharge circuit for total draining • Double Aisi 304 stainless steel tank filter + pump filter • United upper and lower washing/rinsing • Built-in rinse aid dispenser • 3 washing programs (max 24/36/65 racks/h) • Automatic start • Thermostop • Pressure boiler • Tank and boiler thermometers • External detergent dispenser and drain pump as an option • Water inlet temperature ≥ 50°C

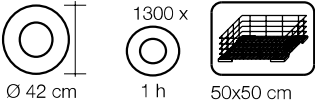
CARACTÉRISTIQUES DE CONSTRUCTION: • Fabrication en acier Inox 18/10 Aisi 304 • Cuve de lavage emboutie, à angles arrondis • Double filtre cuve en acier inox • Groupe aspiration/vidange intégré pour la vidange totale du circuit, avec filtre en acier Inox 18/10 Aisi 304 • Bras de lavage et de rinçage séparés en acier Inox Aisi 304 • Doseur produit de rinçage intégré • 3 cycles de lavage (24/36/65 casiers/h) • Marche automatique • Thermostop • Chaudière à pression • Thermomètres visualisation température cuve et chaudière • Prédisposé pour doseur détergent et pompe de vidange en option • Température de l'eau à l'arrivée ≥ 50°C







HT 52 DT 63,5x71,7x140,5 h cm 140 Kg 0,96 m³ 5.215 €		 11,1 kW 380-415V 3N 50Hz *11,1 kW 220-240V 3 50Hz
HT 53 DT 63,5x71,7x146,5 h cm 140 Kg 0,96 m³ 5.685 €		 11,1 kW 380-415V 3N 50Hz *11,1 kW 220-240V 3 50Hz

* disponibile su richiesta / available on request / disponibles sur demande
 Voltaggio 60Hz disponibile su richiesta con sovrapprezzo / Voltage 60Hz available on request, additional cost / Voltage 60Hz disponible sur demande, coût additionnel

optional

optional

en option

A  281	Addolcitore incorporato (da richiedere all'ordine) Built-in water softener (to request at order) Adoucisseur intégré (à demander au moment de la commande)	L/DD  163 €	Dosatore detergente Detergent dispenser Doseur détergent
VNR  110 €	Dispositivo "non ritorno" (da richiedere all'ordine) VNR non return valve (to request at order) Clapet anti-retour (à demander au moment de la commande)	L/PS HT  176 €	Pompa scarico 0,025 kW Drain pump 0,025 kW Pompe de vidange 0,025 kW
L/PR  273 €	Pompa ausiliaria risciaquo 0,33 kW Rinse-booster pump 0,33 kW Pompe auxiliaire rinçage 0,33 kW	BT *  409 €	Break Tank (da richiedere all'ordine) Break Tank (to request at order) Air Gap (à demander au moment de la commande)

*Solo per i modelli HT 52 DT ed HT 53 DT - Only for HT 52 DT and HT 53 DT models - Seulement pour modèles HT 52 DT et HT 53 DT

dotazione

included accessories

équipement inclus

Cesto per posate
 Rack for cutlery
 Panier à couverts

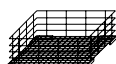

2 cesti per piatti
 2 racks for platesw
 2 paniers à assiettes

20  Ø 24 cm
 10  Ø 34 cm

